

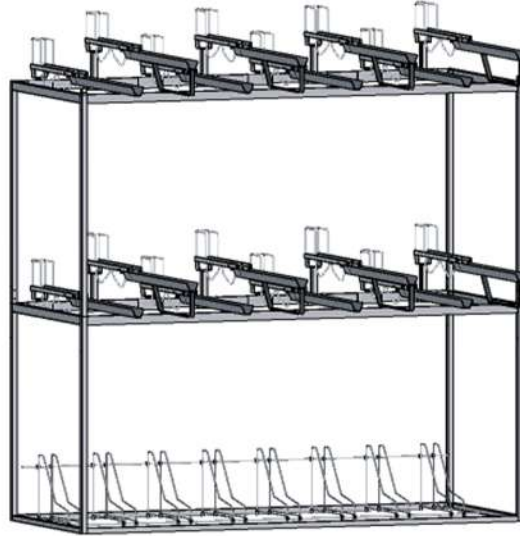

WALL DOUBLE DECKER 3-Tier with Deluxe Space Savers

Designed & Made
in the
USA



HARDWARE

- 1/4" x 3/4" Bolts
- 1/4" x 1-3/4" Bolts
- 1/4" Washers
- 1/4" Stopnuts
- Thread Rolling Bolts
- 5/16" x 1/2" Bolts
- 5/16" X 3/4" Bolts
- 5/16" x 1" Bolts
- 5/16" Washers
- 1/2" x 1" Black Plugs
- 1" Black Plugs
- 1-1/4" Black Plugs
- 1/4" x 3/8" Set Screws

TOOLS NEEDED:

- *socket wrench with 7/16" and 1/2" sockets
- *7/16" wrench
- *1/2" wrench
- *tape measure

**LOCATE ALL PARTS
AND HARDWARE
BEFORE
BEGINNING RACK
ASSEMBLY**

PARTS

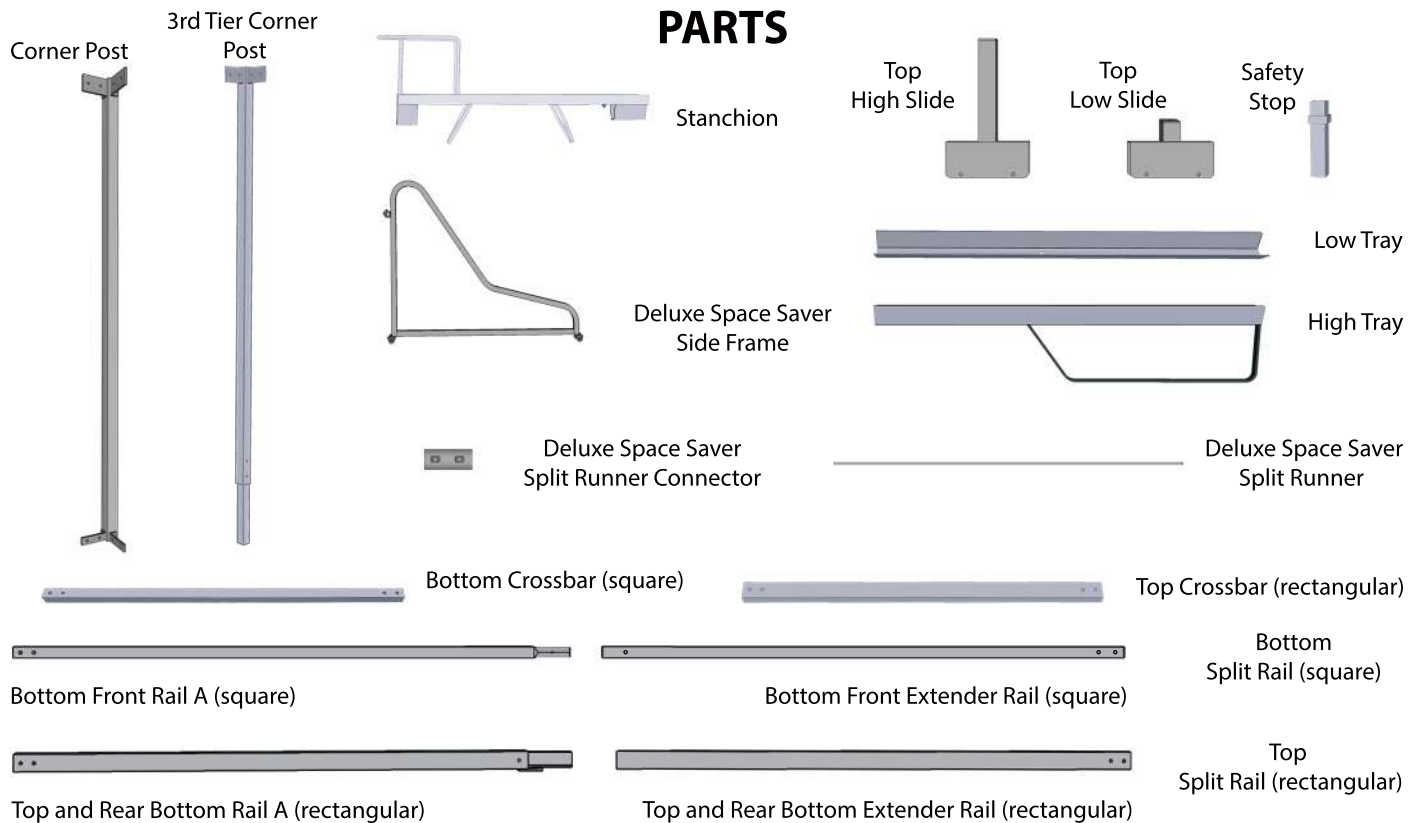

3-Tier Wall Double Decker Rail Assembly

Your Wall Double Decker includes the following rails: (4) Top Rails – Rectangular, and (2) Bottom Rails – Square

Step 1 – Identify Rail Components

Each rail is shipped in two pieces:

Rail A – with end that inserts into the extender



Bottom Rail A (square)



Top Rail A (rectangular)

Rail Extender



Bottom Extender Rail (square)



Top Extender Rail (rectangular)

Step 2 – Assemble Each Rail

Insert Rail A into the Rail Extender until it stops and the connection is flush.

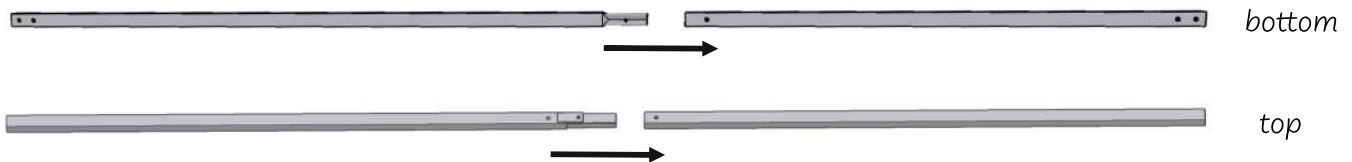

Step 3 – Secure Top Rails

For the four Top Rails, secure using: a 5/16" × 1" Bolt and 5/16" Washer.

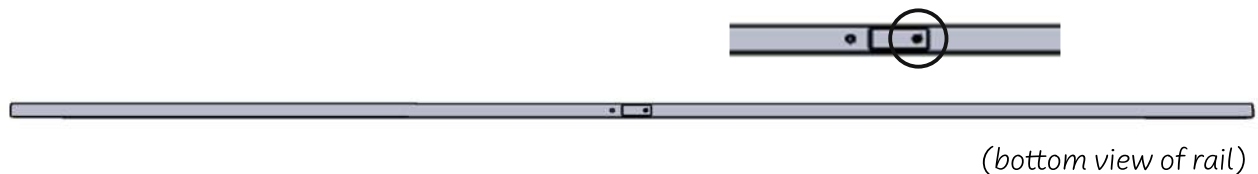

Step 4 – Secure Bottom Rails

For the two Bottom Rails, secure using a Thread Rolling Bolt.



Apply steady downward pressure while turning, as the bolt will widen the hole. (Use a rubber mallet to align holes if needed.)

TRAY ASSEMBLY (HIGH and LOW TRAYS)

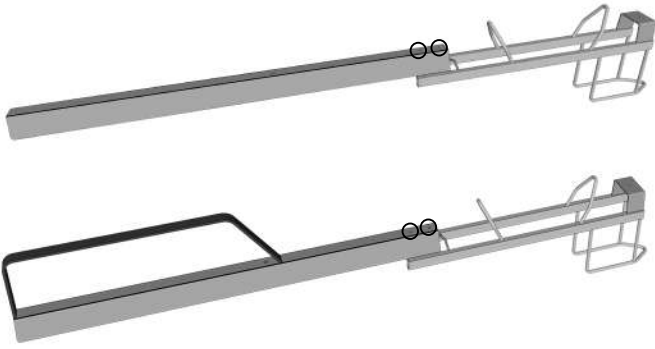

Locate the Stanchions and Trays. Flip a Stanchion and Tray upside down. Align the 2 holes in the Stanchion with the 2 holes in the Tray. The Tray should be on the outside of the Stanchion, as shown.

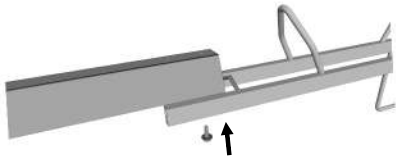

Place a 1/4" washer over a 1/4" x 3/4" Bolt. Insert the assembly through one of the holes. Finger tighten with a 1/4" Washer and 1/4" Stopnut.



Repeat in the open hole, as shown. Tighten using (2) 7/16" Wrenches.

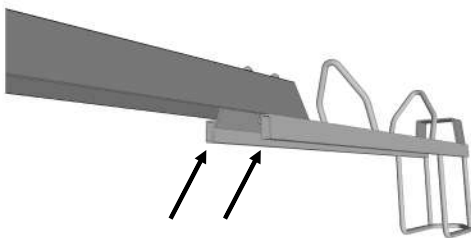

Insert (2) 1/2" x 1" Plugs into the open holes in the front of the Stanchion, as shown.

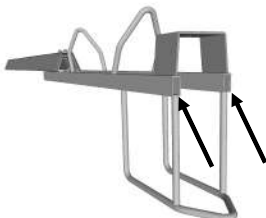

Insert (2) 1/2" x 1" Plugs into the back of the Stanchion, as shown.

Your tray is now complete!

For ease of assembly, finger-tighten all bolts until Step 4 is complete. This will allow for easier adjustments and alignment throughout the process. Once step 4 is complete, securely tighten all bolts to finish 2-Tier Frame Assembly.

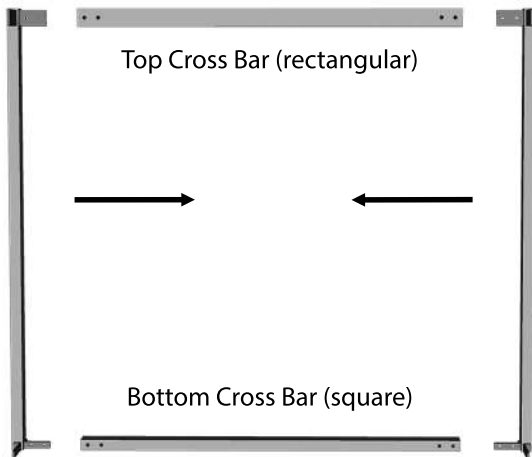

Step 1:

Create the End Assemblies: Locate (2) Corner Posts, (1) Bottom Crossbar, and (1) Top Crossbar.

Create an End Assembly by laying parts on a flat surface, inserting the ears on the Corner Posts into the Crossbars as shown. Secure by hand tightening 5/16" x 1/2" Bolts and 5/16" Washers.

Repeat once more with the remaining Corner Posts and Crossbars to create another End Assembly.

Step 2:

Locate the (2) Bottom Rails [square]. While holding one End Assembly upright with the small ears on the bottom, slide the ends of the rails over the ears as shown.

Secure by hand tightening 5/16" x 1/2" Bolts and 5/16" Washers.

Repeat on the opposite side with the remaining End Assembly.

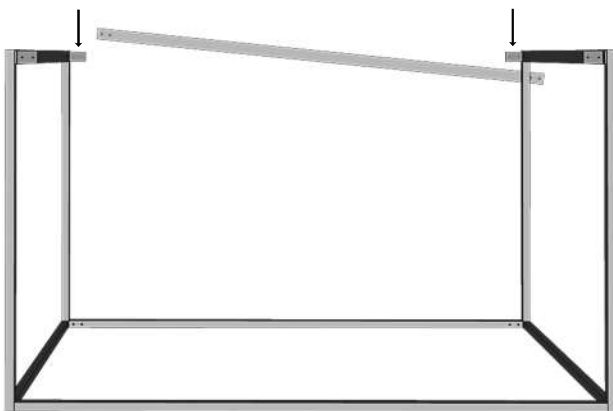
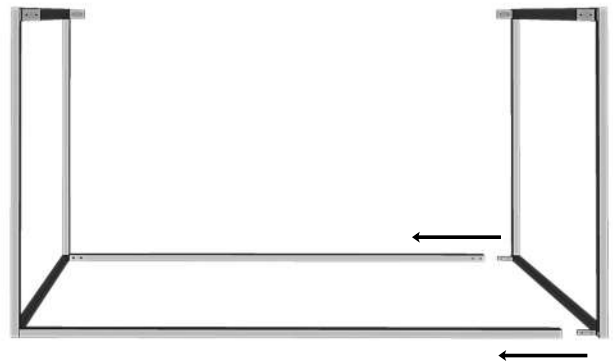

Step 3:

Locate a Top Rail. Slide one end over one of the ears on a Corner Post. Then place the other end of the Rail over the corresponding ear at the other side of the rack, as shown. NOTE: It may take a little force to get onto both ears.

Secure by hand-tightening 5/16" x 1/2" Bolts and 5/16" Washers.

Step 4:

Repeat Step 3 with the front Top Rail. Once again, this may require a little force. Now your structure is complete.

Go back through the entire frame and tighten all bolts. Your 2-Tier Frame is complete!

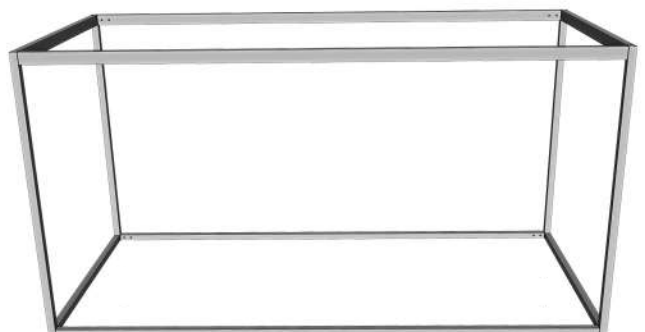

For ease of assembly, finger-tighten all bolts until third tier frame is complete. This will allow for easier adjustments and alignment throughout the process. Once step 7 is complete, securely tighten all bolts to finish frame assembly.

Step 5:

Insert the 3rd Tier Corner Posts into the tops of the lower Corner Posts.

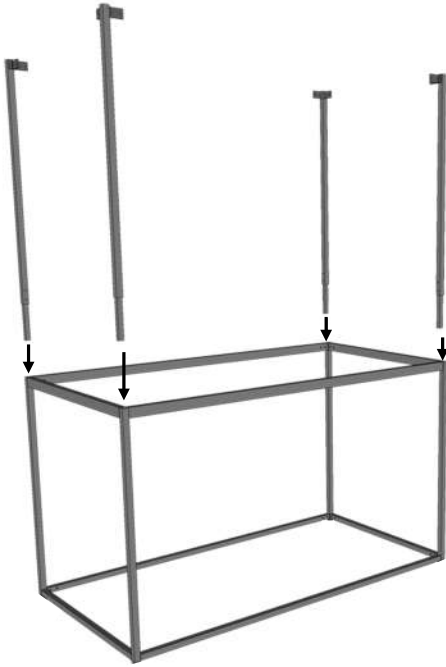

Step 6:

Insert the remaining Top Cross Bars into the ears of the 3rd Tier Corner Posts and secure by finger tightening 5/16" x 1/2" Bolts with 5/16" Washers.

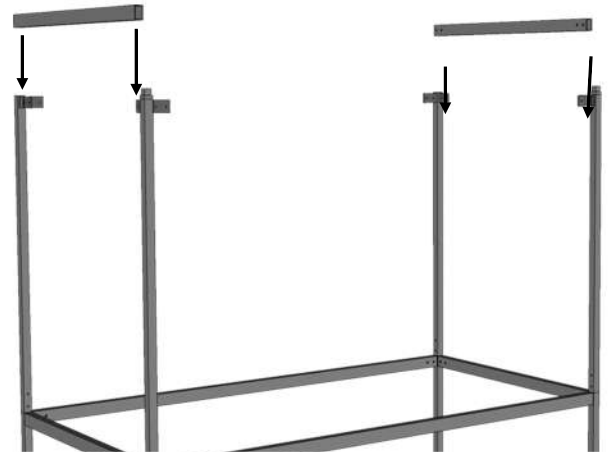

Step 7:

Locate a Top Rail. Slide one end over one of the ears on a 3rd Tier Corner Post. Then place the other end of the Rail over the corresponding ear at the other side of the rack
NOTE: It may take a little force to get onto both ears.

Secure by hand-tightening 5/16" x 1/2" Bolts and 5/16" Washers.

Repeat with the final Top Rail.



Go back through the 3rd Tier Frame and fully secure all bolts.

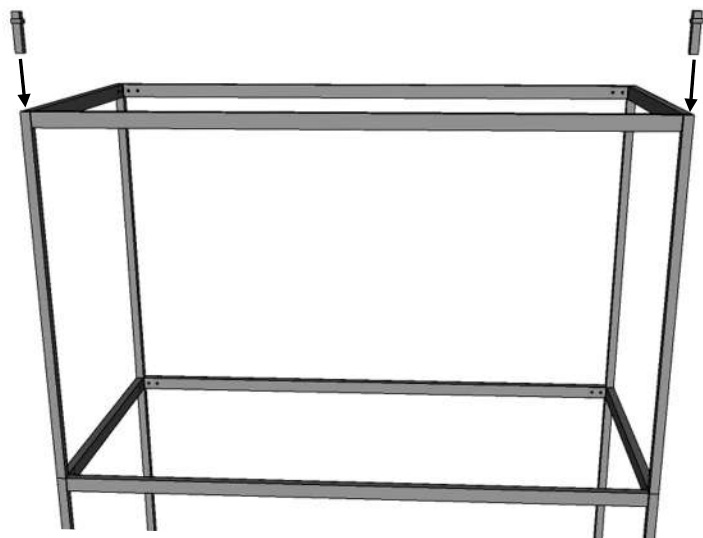

Step 8:

Locate the (2) Safety Stops.



Insert 1" Black Plugs into the top of each Safety Stop and insert the long end of each Safety Stop into the Top Front 3rd Tier Corner Posts.

Step 9:

Locate (2) 1-1/4" Black Plugs and insert them into the Top Rear 3rd Tier Corner Posts.

YOUR 3-TIER FRAME IS NOW COMPLETE!

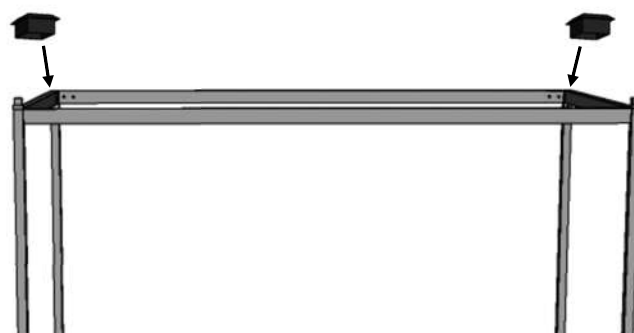

Step 10:

Locate the Top High and Low Slides. Position and space the Slides along the rear second-tier rail, alternating High and Low. Secure each slide using 1/4" x 1-3/4" Bolts and 1/4" Stop Nuts.

Slide Placement Tip:

When placing the slides, we generally recommend leaving approximately 3.5" to 4" of space at each end of the rail. The slides themselves can be spaced approximately 7" to 8" apart (end to end) depending on your setup. The slides can be adjusted to fit your specific needs.

Step 11:

Match the spacing and High/Low orientation, then attach the corresponding High and Low Slides to the third-tier rear rail.

Secure each Slide with 1/4" x 1-3/4" Bolts and 1/4" Stop Nuts.

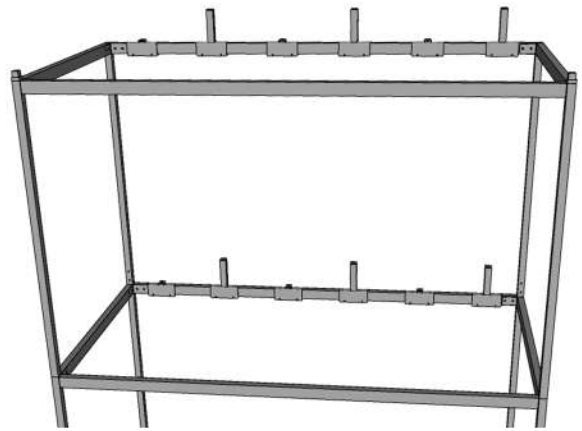

Step 12:

Locate the pre-assembled High and Low Trays.

Attach the Trays to the second tier first, then the third tier, ensuring High Trays align with High Slides and Low Trays with Low Slides.

Secure each Low Tray to its corresponding Low Slide by inserting a 5/16" x 1/2" Bolt with a 5/16" Washer through the rear hole of the tray assembly and into the top of the Slide.

Secure each High Tray to its corresponding High Slide by inserting a 5/16" x 3/4" Bolt with a 5/16" Washer through the rear hold of the tray assembly and into the top of the Slide.

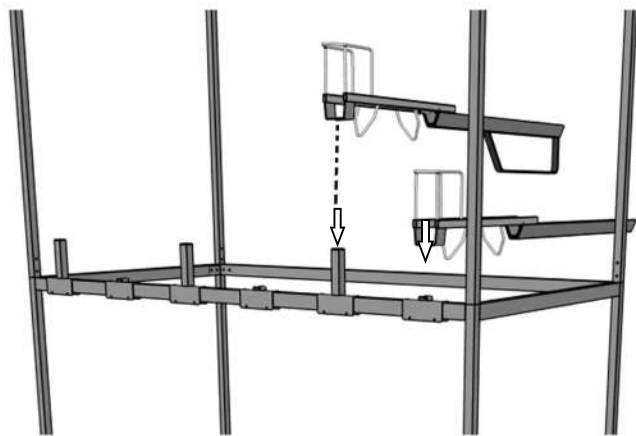

(back view of second tier)

BEFORE LOADING BIKES ON TRAYS:

It is recommended that the rear derailleur is set on the middle cog and the front derailleur is set on the largest chain ring to prevent chain or derailleur damage.

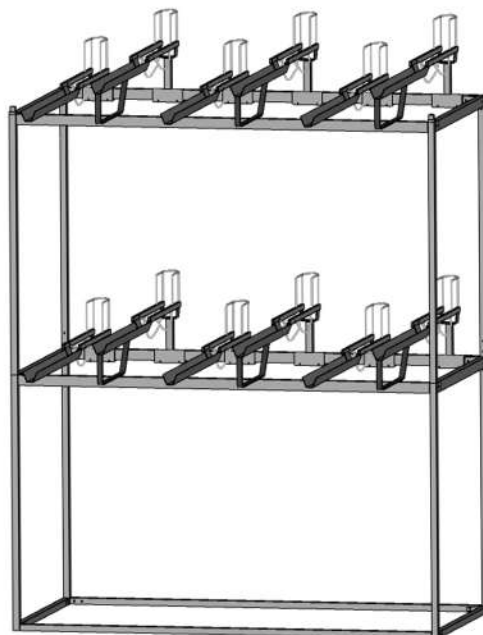

Step 11:

Match the spacing and High/Low orientation, then attach the corresponding High and Low Slides to the third-tier rear rail.

Secure each Slide with 1/4" x 1-3/4" Bolts and 1/4" Stop Nuts.

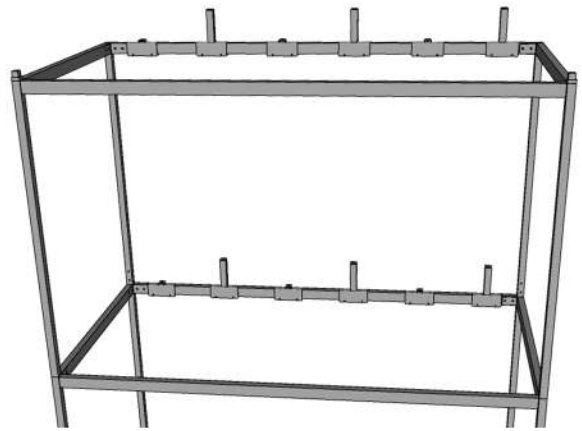

Step 12:

Locate the pre-assembled High and Low Trays.

Attach the Trays to the second tier first, then the third tier, ensuring High Trays align with High Slides and Low Trays with Low Slides.

Secure each Low Tray to its corresponding Low Slide by inserting a 5/16" x 1/2" Bolt with a 5/16" Washer through the rear hole of the tray assembly and into the top of the Slide.

Secure each High Tray to its corresponding High Slide by inserting a 5/16" x 3/4" Bolt with a 5/16" Washer through the rear hold of the tray assembly and into the top of the Slide.

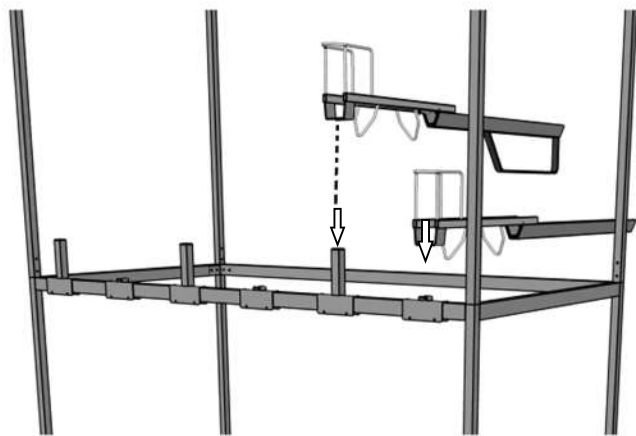

(back view of second tier)

BEFORE LOADING BIKES ON TRAYS:

It is recommended that the rear derailleur is set on the middle cog and the front derailleur is set on the largest chain ring to prevent chain or derailleur damage.

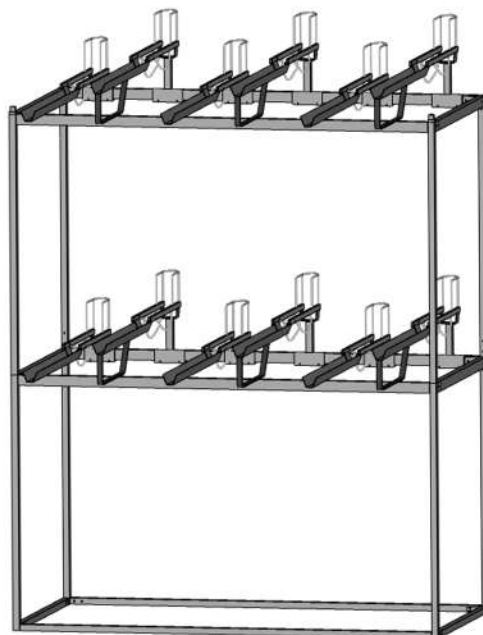

E: Loosen the previously secured Side Frame. Now set the end Side Frame with (3) 1/4" x 3/8" Set Screws.

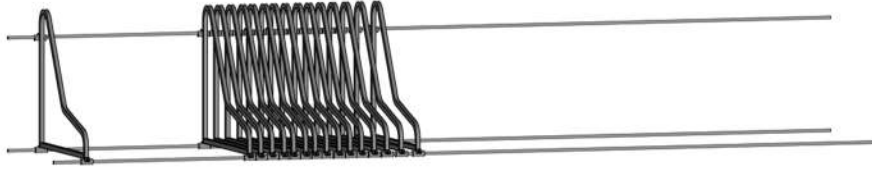

F: Space out your Side Frames by rolling the rear wheel of a bike between two Side Frames. Secure all Side Frames with: (3) 1/4" x 3/8" Set Screws.

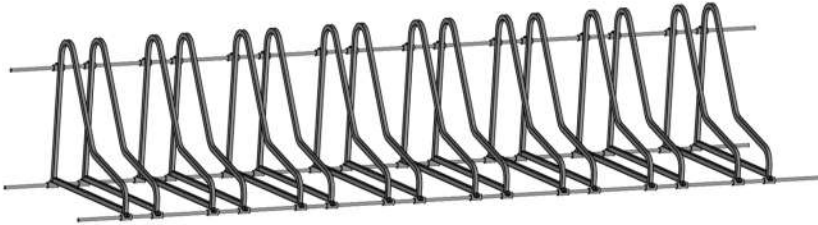

YOUR DELUXE SPACE SAVER IS COMPLETE!

Step 14:

Place the finished Deluxe Space Saver inside the Wall Double Decker frame, as shown.

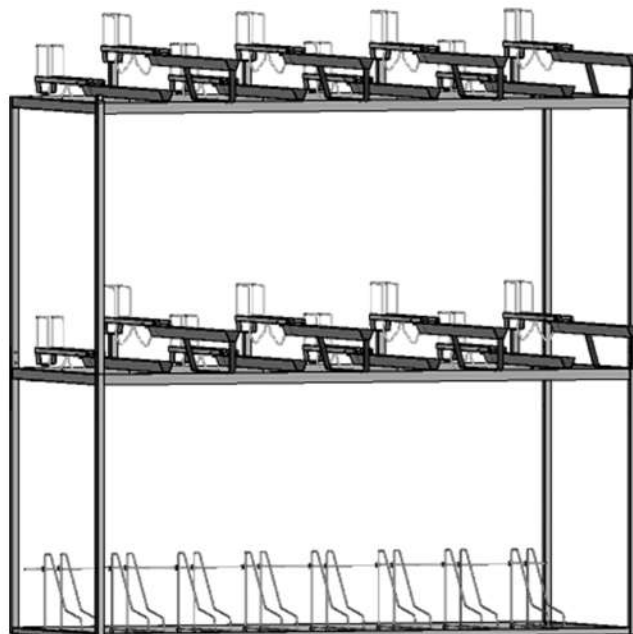

**YOUR RACK IS
NOW COMPLETE!**