

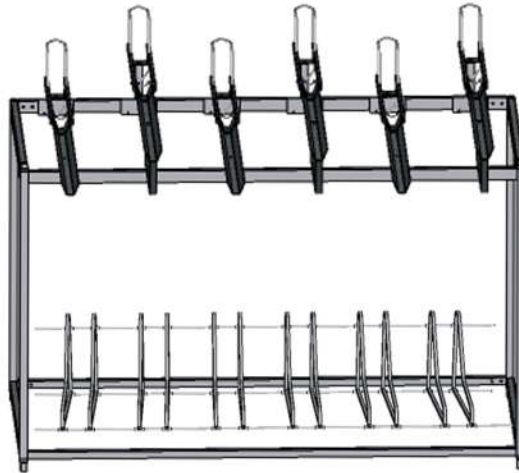

WALL DOUBLE DECKER with Deluxe Space Savers

Designed & Made
in the
USA



HARDWARE

- 1/4" x 3/4" Bolts
- 1/4" x 1-3/4" Bolts
- 1/4" Washers
- 1/4" Stopnuts
- Thread Rolling Bolts
- 5/16" x 1/2" Bolts
- 5/16" X 3/4" Bolts
- 5/16" x 1" Bolts
- 5/16" Washers
- 1/2" x 1" Black Plugs
- 1" Black Plugs
- 1-1/4" Black Plugs
- 1/4" x 3/8" Set Screws

TOOLS NEEDED:

- *socket wrench with 7/16" and 1/2" sockets
- *7/16" wrench
- *1/2" wrench
- *tape measure

**LOCATE ALL PARTS
AND HARDWARE
BEFORE
BEGINNING RACK
ASSEMBLY**

PARTS

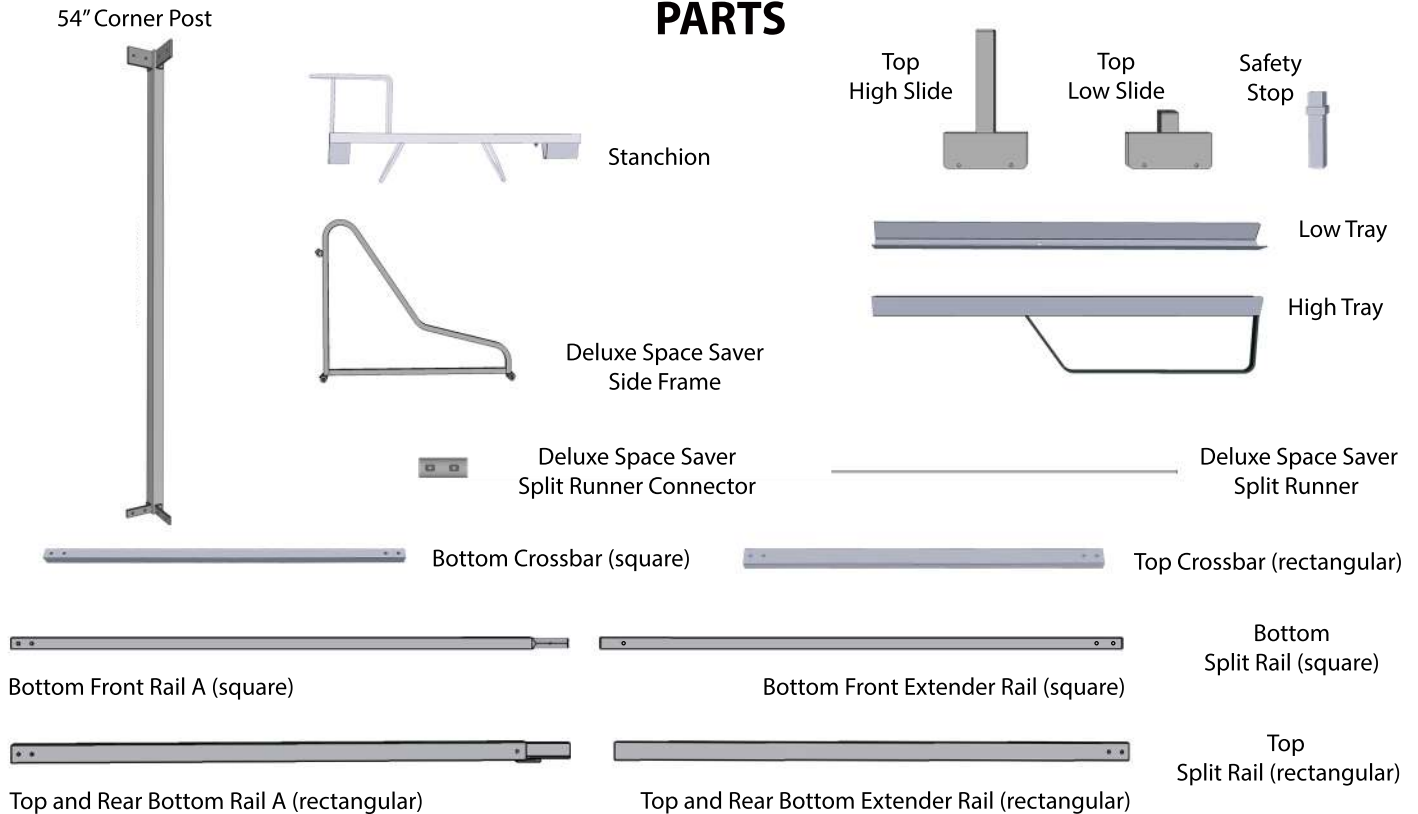

Wall Double Decker Rail Assembly

Your Wall Double Decker includes the following rails: (2) Top Rails – Rectangular, and (2) Bottom Rails – Square

Step 1 – Identify Rail Components

Each rail is shipped in two pieces:

Rail A – with end that inserts into the extender



Bottom Rail A (square)



Top Rail A (rectangular)

Rail Extender



Bottom Extender Rail (square)



Top Extender Rail (rectangular)

Step 2 – Assemble Each Rail

Insert Rail A into the Rail Extender until it stops and the connection is flush.

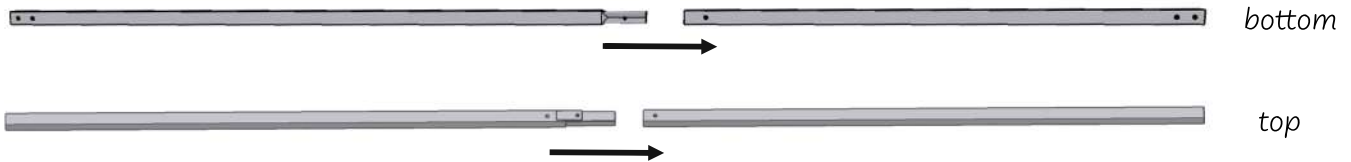

Step 3 – Secure Top Rails

For the two Top Rails, secure using: a 5/16" × 1" Bolt and 5/16" Washer.

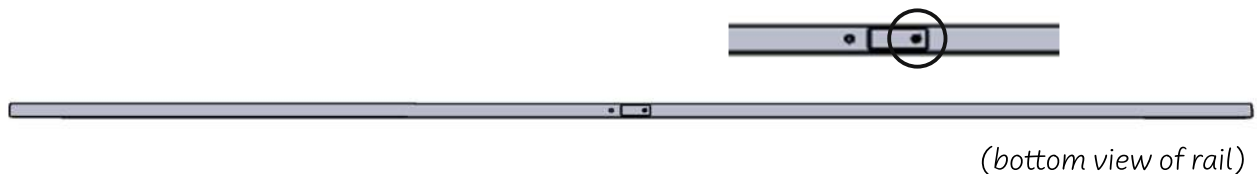

Step 4 – Secure Bottom Rails

For the two Bottom Rails, secure using a Thread Rolling Bolt.



Apply steady downward pressure while turning, as the bolt will widen the hole. (Use a rubber mallet to align holes if needed.)

TRAY ASSEMBLY (HIGH and LOW TRAYS)

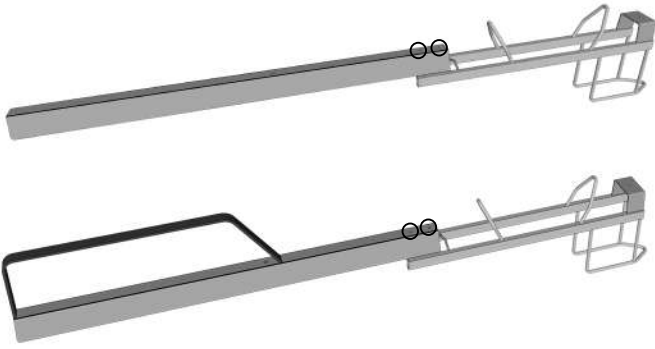

Locate the Stanchions and Trays. Flip a Stanchion and Tray upside down. Align the 2 holes in the Stanchion with the 2 holes in the Tray. The Tray should be on the outside of the Stanchion, as shown.

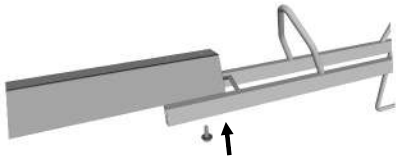

Place a 1/4" washer over a 1/4" x 3/4" Bolt. Insert the assembly through one of the holes. Finger tighten with a 1/4" Washer and 1/4" Stopnut.



Repeat in the open hole, as shown. Tighten using (2) 7/16" Wrenches.

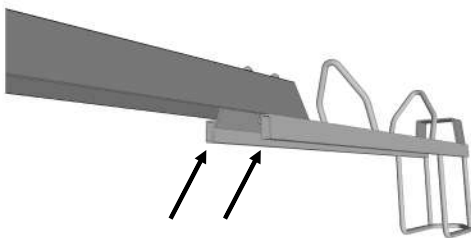

Insert (2) 1/2" x 1" Plugs into the open holes in the front of the Stanchion, as shown.

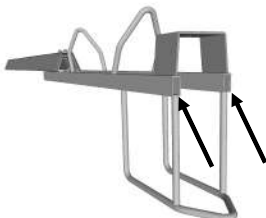

Insert (2) 1/2" x 1" Plugs into the back of the Stanchion, as shown.

Your tray is now complete!

For ease of assembly, finger-tighten all bolts until Step 4 is complete. This will allow for easier adjustments and alignment throughout the process. Once step 4 is complete, securely tighten all bolts to finish frame assembly.

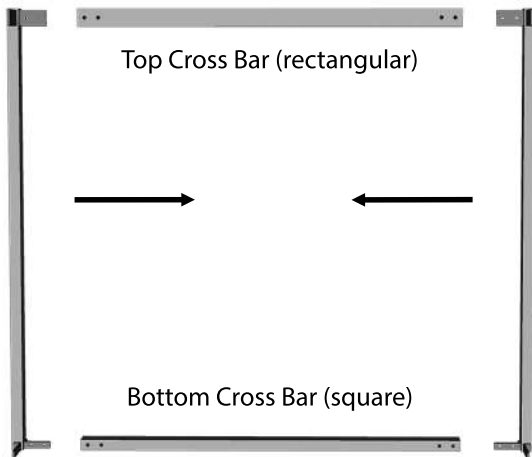

Step 1:

Create the End Assemblies.: Locate (2) Corner Posts, (1) Bottom Crossbar, and (1) Top Crossbar.

Create an End Assembly by laying parts on a flat surface, inserting the ears on the Corner Posts into the Crossbars as shown. Secure by hand tightening 5/16" x 1/2" Bolts and 5/16" Washers.

Repeat once more with the remaining Corner Posts and Crossbars to create another End Assembly.

Step 2:

Locate the (2) Bottom Rails [square]. While holding one End Assembly upright with the small ears on the bottom, slide the ends of the rails over the ears as shown.

Secure by hand tightening 5/16" x 1/2" Bolts and 5/16" Washers.

Repeat on the opposite side with the remaining End Assembly.

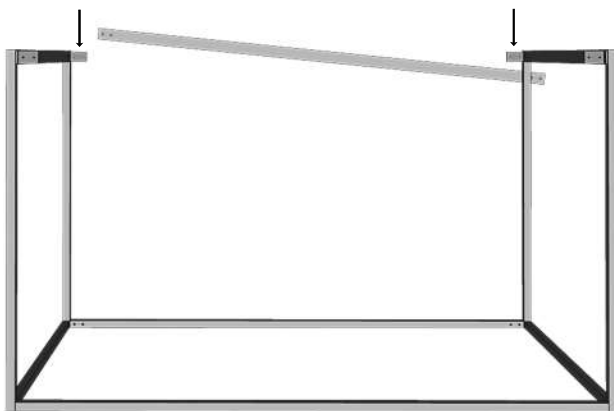
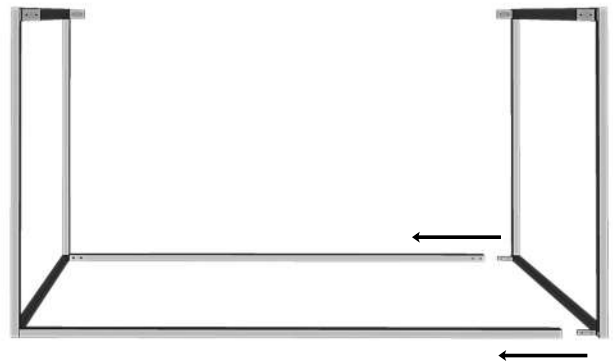

Step 3:

Locate a Top Rail. Slide one end over one of the ears on a Corner Post. Then place the other end of the Rail over the corresponding ear at the other side of the rack, as shown. NOTE: It may take a little force to get onto both ears.

Secure by hand-tightening 5/16" x 1/2" Bolts and 5/16" Washers.

Step 4:

Repeat Step 3 with the remaining Top Rail. Once again, this may require a little force. Now your structure is complete.

Go back through the entire frame and tighten all bolts.

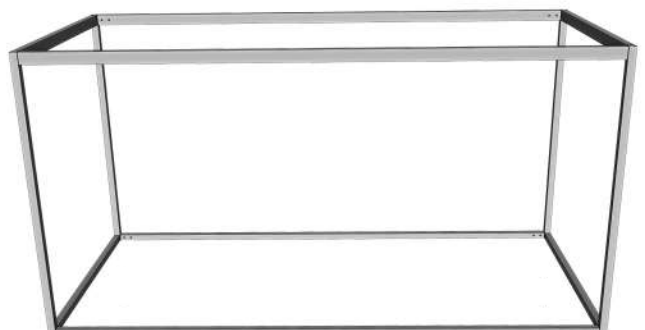

Step 5:

Find the High and Low Slides and position them along the Top Rear Rail. Begin at one end, alternating High and Low slides as illustrated. Secure each slide with 1/4" x 1-3/4" Bolts and 1/4" Stopnuts.

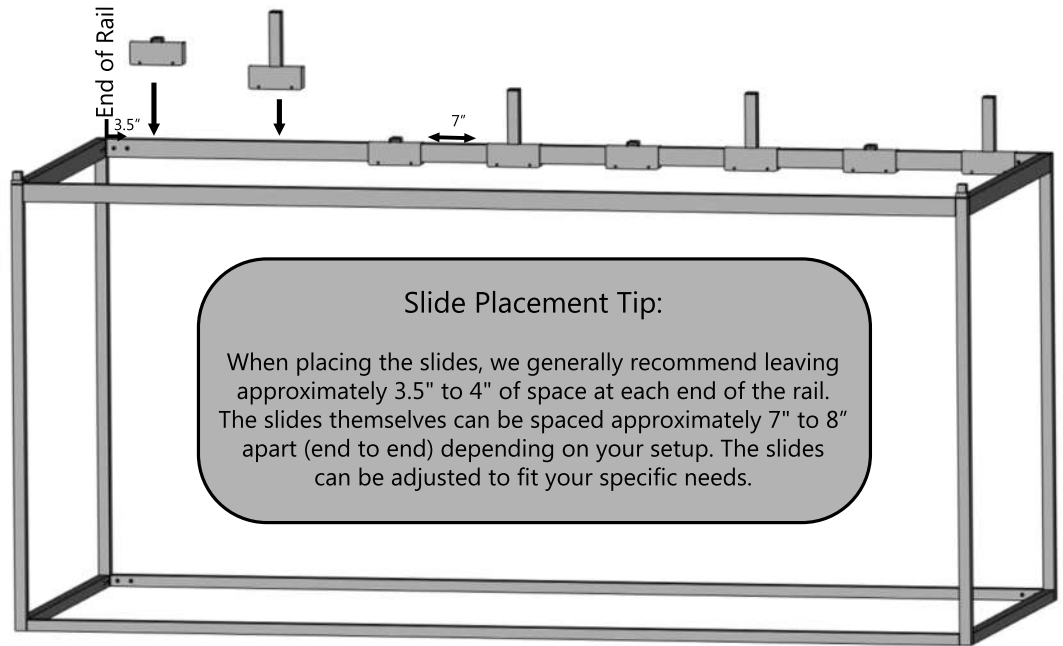

Step 6:

Attach each Tray Assembly to its matching Slide—Low Trays to Low Slides, and High Trays to High Slides. Insert the bolt through the back hole of the tray assembly and into the hole on top of the slide.

Secure Low Trays using 5/16" x 1/2" Bolts and 5/16" Washers, and High Trays using 5/16" x 3/4" Bolts and 5/16" Washers.

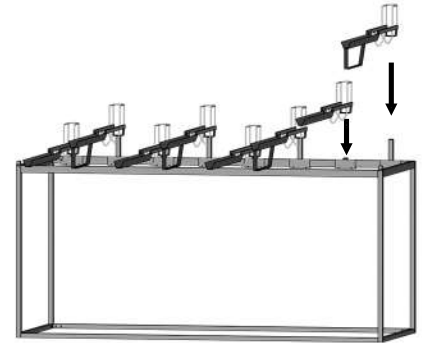

Step 7:

Locate the two Safety Stops. Push a 1" Black Plug into the top, as shown. Insert each Safety Stop into one of the Front Corner Posts. Next insert 1-1/4" Black Plugs into the tops of the Rear Connector Posts.

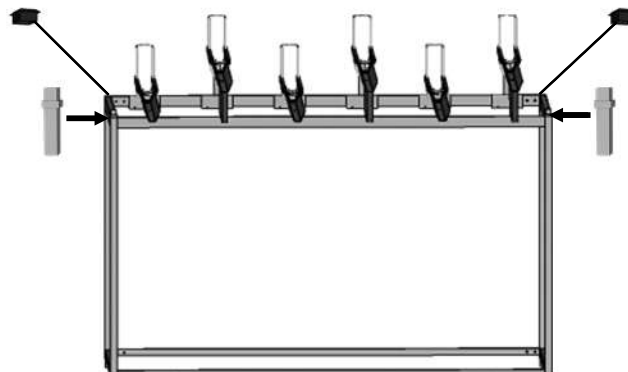
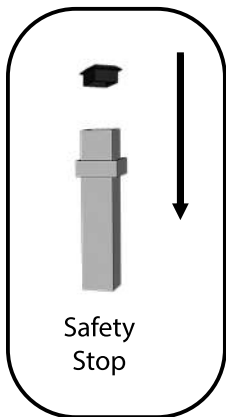

Step 8: Deluxe Space Saver Assembly

- A:** Begin by assembling the Runners. Each runner assembles from two split Runners and one Connector. Insert both split Runners into the Connector, aligning them so they meet at the center within the Connector and secure with Set Screws.

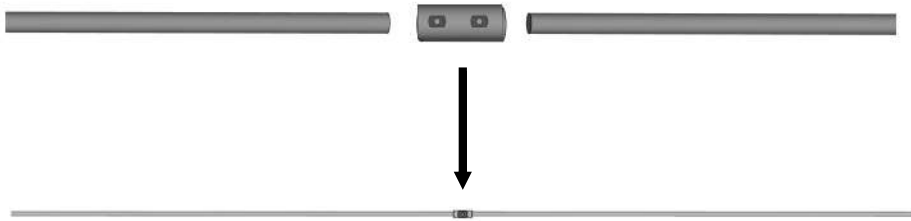

- B:** Locate (2) of the Deluxe Space Saver Runners. Lay them out on the floor with roughly 18" between them.

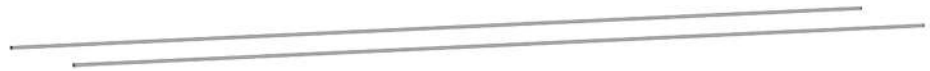

- C:** Next, take one of the Side Frames and slide the two bottom tubes through the Runners. Slide it down 16-20" from the end and secure to the Runners using 1/4" x 3/8" Set Screws.

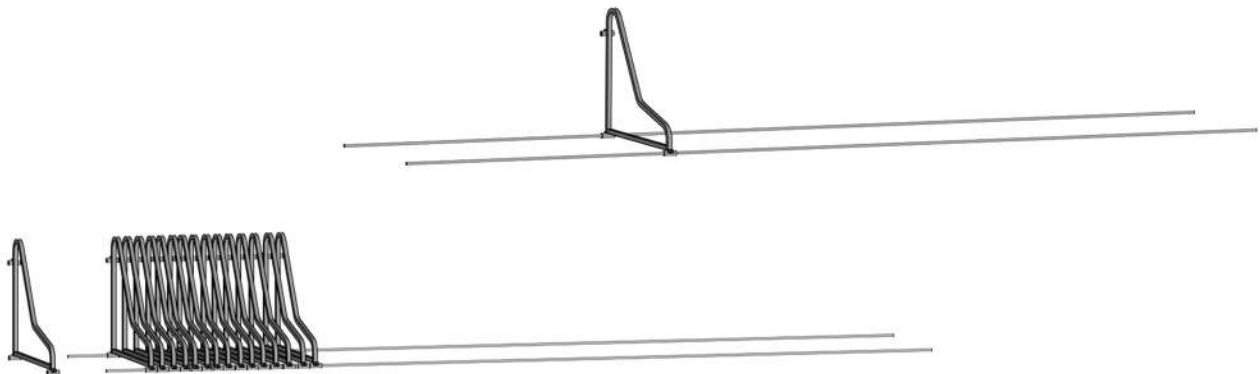

Slide the remaining Side Frames through the Runners, as shown.

- D:** Slide the final Runner through the top tubes of the Side Frames.



Back View

E: Loosen the previously secured Side Frame. Now set the end Side Frame with (3) 1/4" x 3/8" Set Screws.

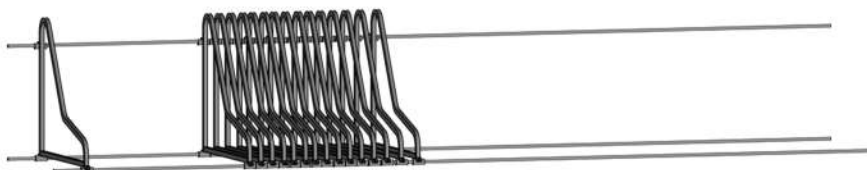

F: Space out your Side Frames by rolling the rear wheel of a bike between two Side Frames.

Secure all Side Frames with:
(3) 1/4" x 3/8" Set Screws.

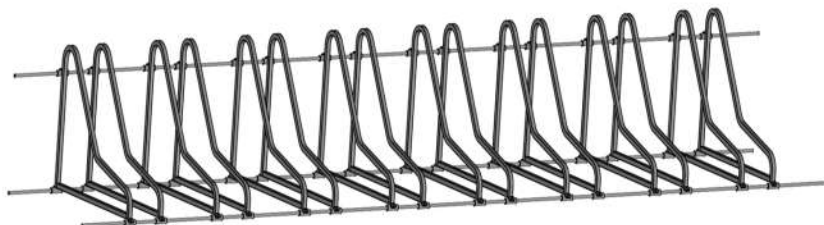

YOUR DELUXE SPACE SAVER IS COMPLETE!

Step 9:

Place the finished Deluxe Space Saver inside the Wall Double Decker frame, as shown.

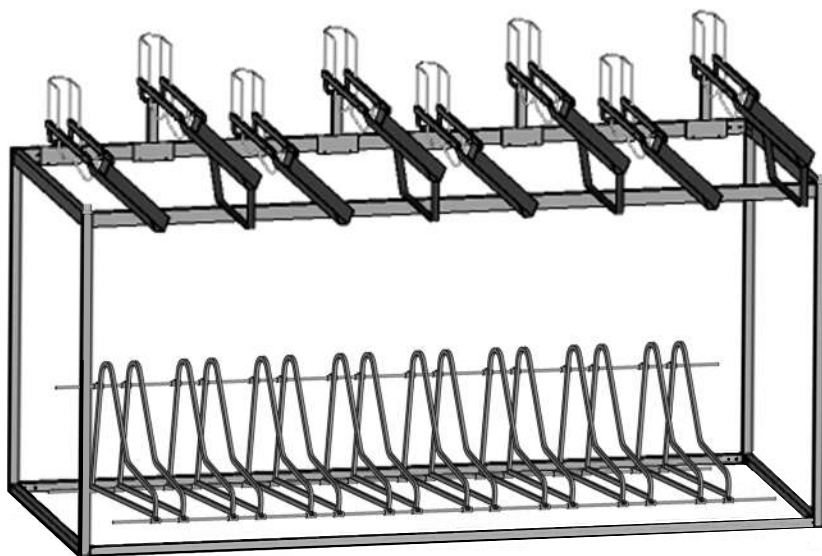

Before loading bikes: If your bike has a rear derailleur it is recommended that the rear derailleur is set to the lowest gear (the largest rear chain ring) to prevent chain or derailleur damage

YOUR RACK IS
NOW COMPLETE!